

## LOW-POWER AND LOW-OFFSET-VOLTAGE DUAL C-MOS OPERATIONAL AMPLIFIER

### ■ GENERAL DESCRIPTION

The NJU7094,95 and 96 are dual C-MOS operational amplifiers operated on a single-power-supply, low voltage and low operating current.

The input offset voltage is lower than 2mV, and the input bias current is as low as than 1pA, consequently very small signal around the ground level can be amplified.

The minimum operating voltage is 1V and the output stage permits output signal to swing between both of the supply rails.

Furthermore, this series is packaged with a various small one therefore it can be especially applied to portable items.

### ■ PACKAGE OUTLINE



NJU709XD



NJU709XM



NJU709XV



NJU709XR



NJU709XR B1

### ■ FEATURES

- Single-Power-Supply
- Low Offset Voltage ( $V_{IO}=2\text{mV max}$ )
- Wide Operating Voltage ( $V_{DD}=1\sim 5.5\text{V}$ )
- Wide Output Swing Range ( $V_{OM}=2.9\text{V min. @ }3.0\text{V}$ )
- Low Operating Current
- Low Bias Current ( $I_{IB}=1\text{pA typ.}$ )
- Compensation Capacitor Incorporated
- Package Outline DIP8, DMP8, SSOP8, VSP8, TVSP8
- C-MOS Technology

### ■ PIN CONFIGURATION

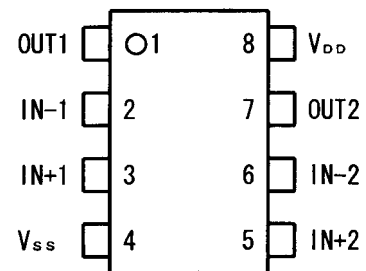

### ■ LINE-UP

( $T_a=25^\circ\text{C}, V_{DD}=3.0\text{V}, \text{Per Circuit}$ )

PARAMETER	NJU7094	NJU7095	NJU7096	UNIT
Operating Current	15	80	200	$\mu\text{A}$ (typ)
Slew Rate	0.1	1.0	2.4	$\text{V}/\mu\text{s}$ (typ)
Unity Gain Bandwidth	0.2	1.0	1.0	$\text{MHz}$ (typ)

### ■ EQUIVALENT CIRCUIT

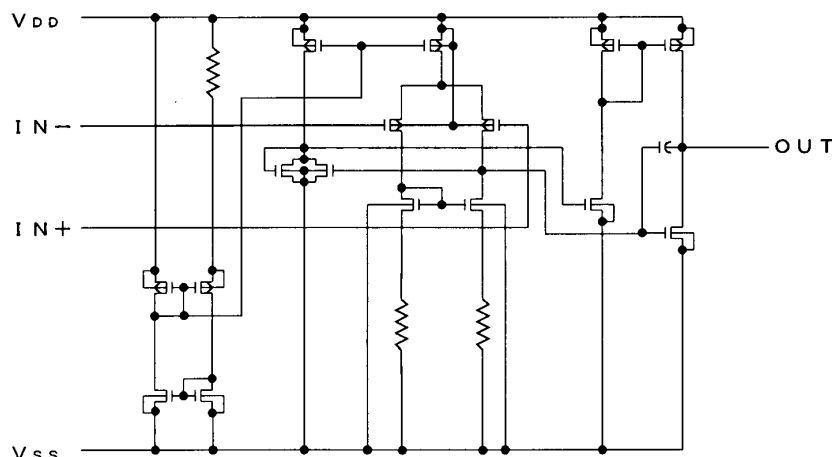

# NJU7094/95/96

## ■ ABSOLUTE MAXIMUM RATINGS

( Ta=25°C )

PARAMETER	SYMBOL	RATINGS	UNIT
Supply Voltage	V <sub>DD</sub>	7	V
Differential Input Voltage	V <sub>ID</sub>	±7 ( note1 )	V
Common Mode Input Voltage	V <sub>IC</sub>	-0.3~7	V
Power Dissipation	P <sub>D</sub>	( DIP8 ) 500 ( DMP8 ) 300 ( SSOP8 ) 250 ( VSP8 ) 320 ( TVSP8 ) 320	mW
Operating Temperature Range	T <sub>opr</sub>	-40~+85	°C
Storage Temperature Range	T <sub>stg</sub>	-55~+125	°C

( note1 ) If the supply voltage ( V<sub>DD</sub> ) is less than 7V, the input voltage must not over the V<sub>DD</sub> level though 7V is limit specified.

( note2 ) Decoupling capacitor should be connected between V<sub>DD</sub> and V<sub>SS</sub> for the stable operation.

## ■ ELECTRICAL CHARACTERISTICS

### NJU7094

( Ta=25°C, V<sub>DD</sub>=3.0V, R<sub>L</sub>=∞ )

PARAMETER	SYMBOL	TEST CONDITION	MIN.	TYP.	MAX.	UNIT
Input Offset Voltage	V <sub>IO</sub>	V <sub>IN</sub> =1/2V <sub>DD</sub>	-	-	2	mV
Input Offset Current	I <sub>IO</sub>		-	1	-	pA
Input Bias Current	I <sub>IB</sub>		-	1	-	pA
Input Impedance	R <sub>IN</sub>		-	1	-	TΩ
Large Signal Voltage Gain	A <sub>VD</sub>		60	70	-	dB
Input Common Mode Voltage Range	V <sub>ICM</sub>		0~2.5	-	-	V
Maximum Output Swing Voltage	V <sub>OM1</sub>	R <sub>L</sub> =1MΩ	V <sub>DD</sub> -0.1	-	-	V
	V <sub>OM2</sub>	R <sub>L</sub> =1MΩ	-	-	V <sub>SS</sub> +0.1	V
Common Mode Rejection Ratio	CMR	V <sub>IN</sub> =1/2V <sub>DD</sub>	55	65	-	dB
Supply Voltage Rejection Ratio	SVR	V <sub>DD</sub> =1.5~5.5V	60	70	-	dB
Operating Current	I <sub>DD</sub>	Per Circuit	-	15	25	μA
Slew Rate	SR		-	0.1	-	V/μs
Unity Gain Bandwidth	F <sub>t</sub>	A <sub>v</sub> =40dB, C <sub>L</sub> =10pF	-	0.2	-	MHz

( note3 ) The source current is less than 2.9μA ( at V<sub>OM</sub>/R<sub>L</sub>=2.9V/1MΩ ).

## NJU7095

( Ta=25°C, V<sub>DD</sub>=3.0V, R<sub>L</sub>=∞ )

PARAMETER	SYMBOL	TEST CONDITION	MIN.	TYP.	MAX.	UNIT
Input Offset Voltage	V <sub>IO</sub>	V <sub>IN</sub> =1/2V <sub>DD</sub>	-	-	2	mV
Input Offset Current	I <sub>IO</sub>		-	1	-	pA
Input Bias Current	I <sub>IB</sub>		-	1	-	pA
Input Impedance	R <sub>IN</sub>		-	1	-	TΩ
Large Signal Voltage Gain	A <sub>VD</sub>		60	70	-	dB
Input Common Mode Voltage Range	V <sub>ICM</sub>		0~2.5	-	-	V
Maximum Output Swing Voltage	V <sub>OM1</sub>	R <sub>L</sub> =100kΩ	V <sub>DD</sub> -0.1	-	-	V
	V <sub>OM2</sub>	R <sub>L</sub> =100kΩ	-	-	V <sub>SS</sub> +0.1	V
Common Mode Rejection Ratio	CMR	V <sub>IN</sub> =1/2V <sub>DD</sub>	55	65	-	dB
Supply Voltage Rejection Ratio	SVR	V <sub>DD</sub> =1.5~5.5V	60	70	-	dB
Operating Current	I <sub>DD</sub>	Per Circuit	-	80	160	μA
Slew Rate	SR		-	1.0	-	V/μs
Unity Gain Bandwidth	F <sub>t</sub>	A <sub>v</sub> =40dB, C <sub>L</sub> =10pF	-	1.0	-	MHz

( note4 ) The source current is less than 29μA ( at V<sub>OM</sub>/R<sub>L</sub>=2.9V/100kΩ ).

## NJU7096

( Ta=25°C, V<sub>DD</sub>=3.0V, R<sub>L</sub>=∞ )

PARAMETER	SYMBOL	TEST CONDITION	MIN.	TYP.	MAX.	UNIT
Input Offset Voltage	V <sub>IO</sub>	V <sub>IN</sub> =1/2V <sub>DD</sub>	-	-	2	mV
Input Offset Current	I <sub>IO</sub>		-	1	-	pA
Input Bias Current	I <sub>IB</sub>		-	1	-	pA
Input Impedance	R <sub>IN</sub>		-	1	-	TΩ
Large Signal Voltage Gain	A <sub>VD</sub>		60	70	-	dB
Input Common Mode Voltage Range	V <sub>ICM</sub>		0~2.5	-	-	V
Maximum Output Swing Voltage	V <sub>OM1</sub>	R <sub>L</sub> =50kΩ	V <sub>DD</sub> -0.1	-	-	V
	V <sub>OM2</sub>	R <sub>L</sub> =50kΩ	-	-	V <sub>SS</sub> +0.1	V
Common Mode Rejection Ratio	CMR	V <sub>IN</sub> =1/2V <sub>DD</sub>	55	65	-	dB
Supply Voltage Rejection Ratio	SVR	V <sub>DD</sub> =1.5~5.5V	60	70	-	dB
Operating Current	I <sub>DD</sub>	Per Circuit	-	200	400	μA
Slew Rate	SR		-	1.0	-	V/μs
Unity Gain Bandwidth	F <sub>t</sub>	A <sub>v</sub> =40dB, C <sub>L</sub> =10pF	-	1.0	-	MHz

( note5 ) The source current is less than 58μA ( at V<sub>OM</sub>/R<sub>L</sub>=2.9V/50kΩ ).

# NJU7094/95/96

## ■ TYPICAL CHARACTERISTICS

(1) NJU7094

Output Voltage vs. Output Current (SOURCE)

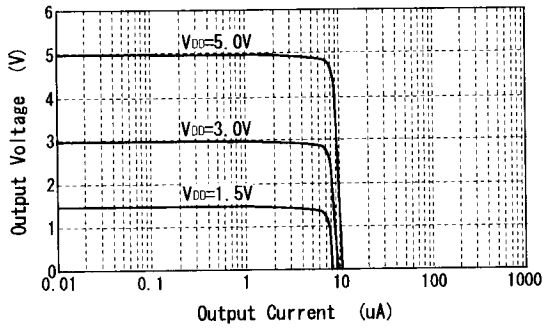

Output Voltage vs. Output Current (SINK)

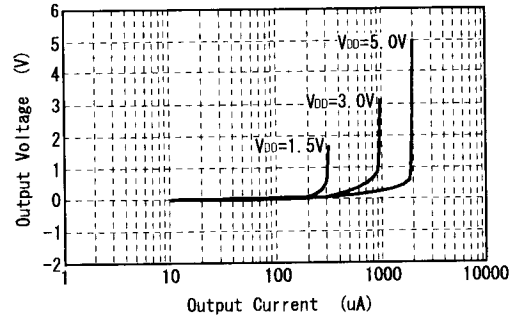

Offset Voltage vs. Operating Voltage

V<sub>IN</sub>=0.1V

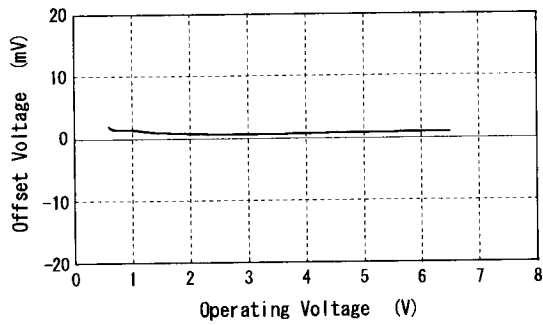

Offset Voltage vs. Input Voltage

V<sub>DD</sub>=3.0V

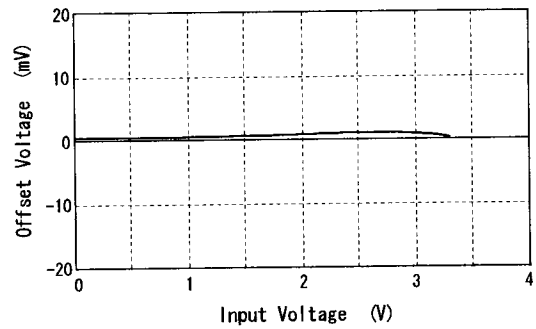

Operating Current vs. Operating Voltage

V<sub>IN</sub>=0.1V

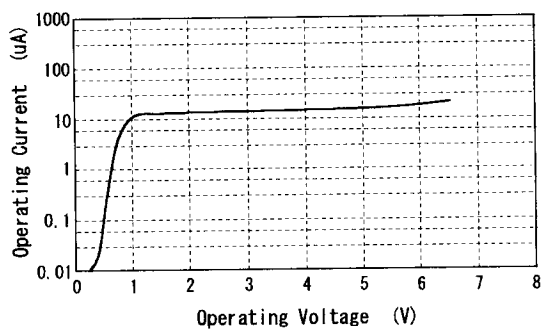

Output Current vs. Operating Voltage

V<sub>IN</sub>=0.1V

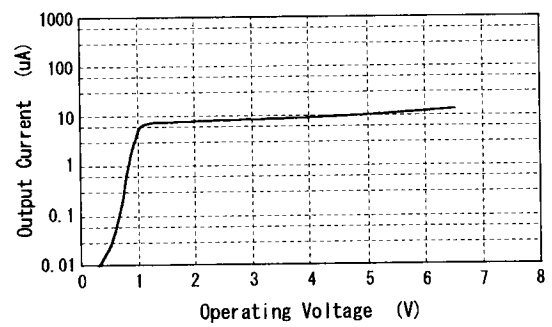

Maximum Output Swing Voltage vs. Load Resistance

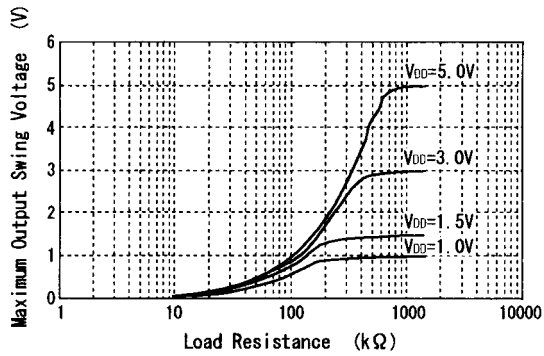

Maximum Output Swing Voltage vs. Frequency

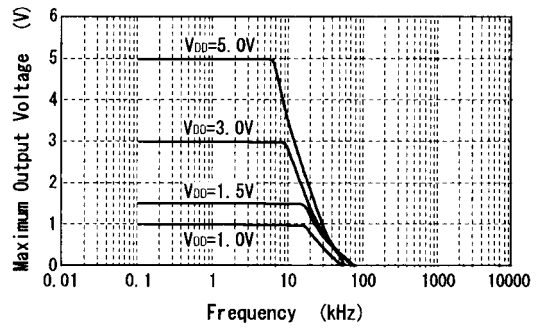

Voltage Gain-Phase vs. Frequency

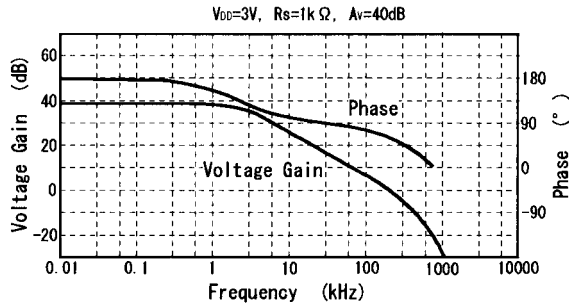

# NJU7094/95/96

(2) NJU7095

Output Voltage vs. Output Current (SOURCE)

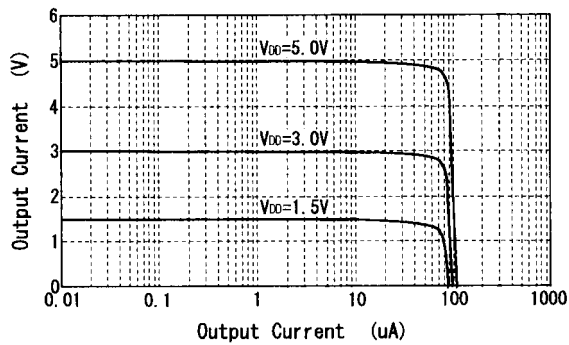

Output Voltage vs. Output Current (SINK)

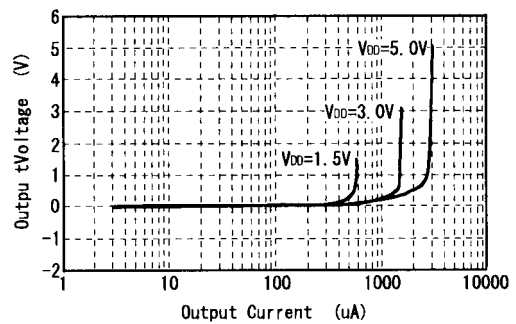

Offset Voltage vs. Operating Voltage

$V_{IN}=0.1V$

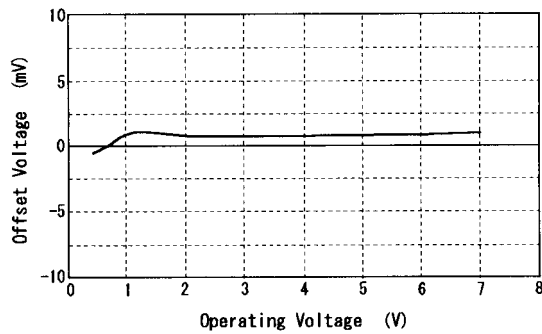

Offset Voltage vs. Input Voltage

$V_{DD}=3.0V$

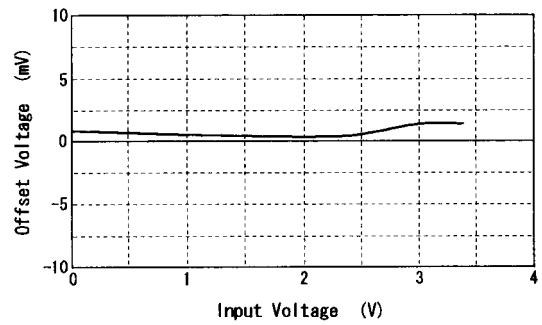

Operating Current vs. Operating Voltage

$V_{IN}=0.1V$

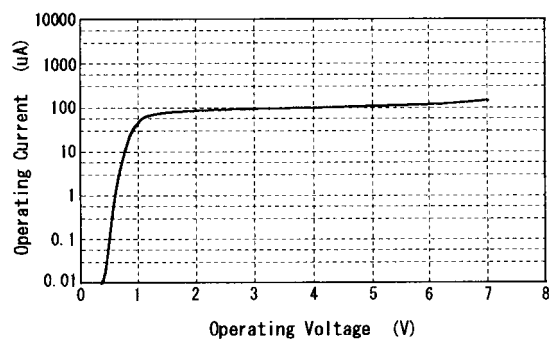

Output Current vs. Operating Voltage

$V_{IN}=0.1V$

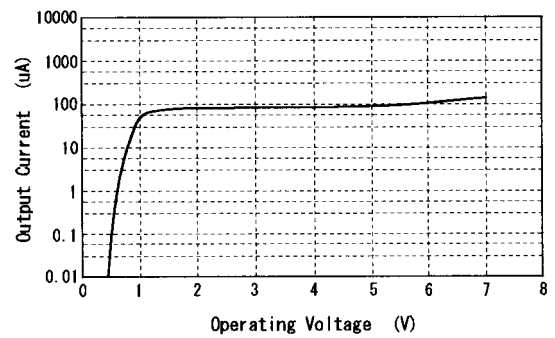

Maximum Output Swing Voltage vs. Load Resistance

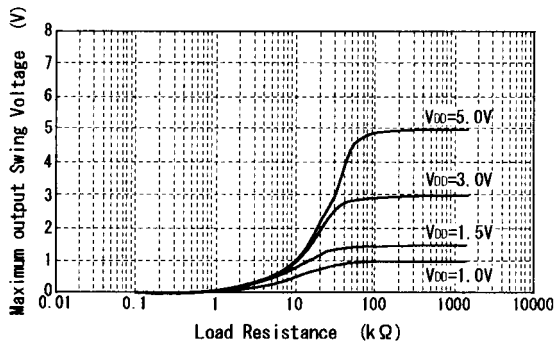

Maximum Output Swing Voltage vs. Frequency

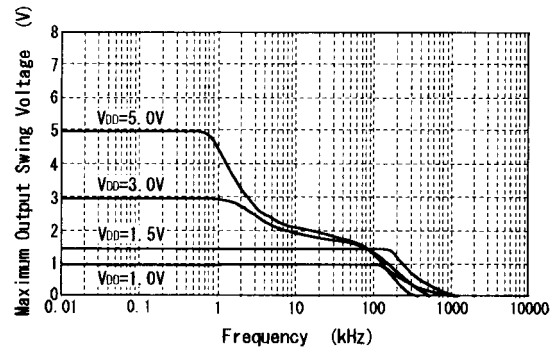

Voltage Gain-Phase vs. Frequency

V<sub>DD</sub>=3V, R<sub>S</sub>=1kΩ, A<sub>v</sub>=40dB

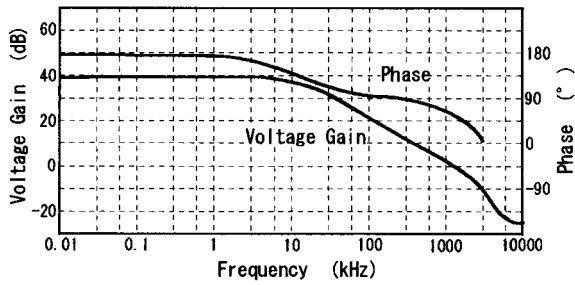

(3) NJU7096

Output Voltage vs. Output Current (SOURCE)

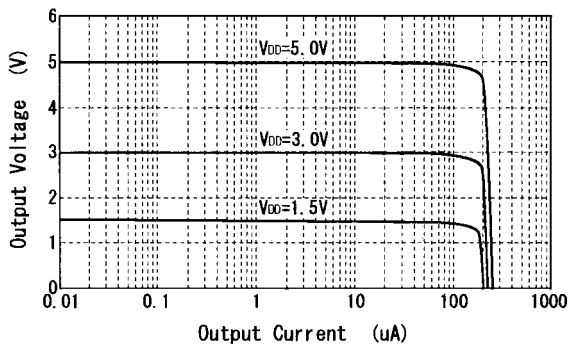

Output Voltage vs. Output Current (SINK)

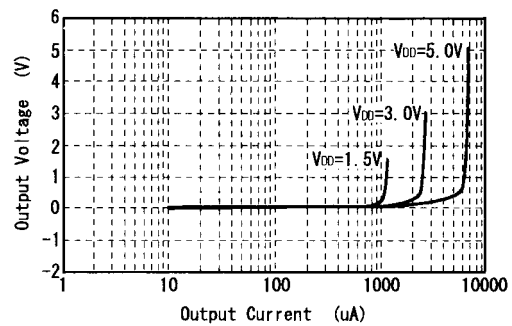

Offset Voltage vs. Operating Voltage

V<sub>IN</sub>=0.1V

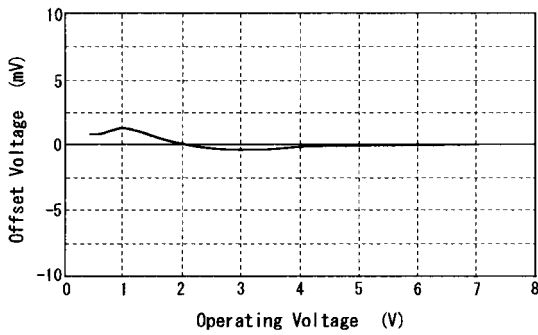

Offset Voltage vs. Input Voltage

V<sub>DD</sub>=3.0V

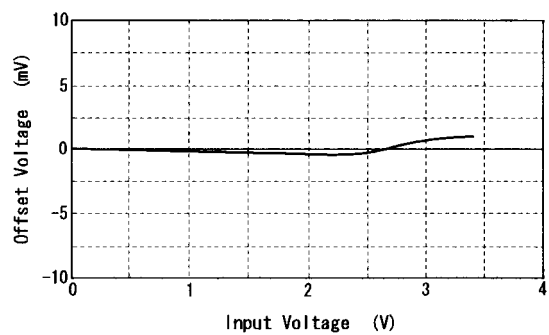

Operating Current vs. Operating Voltage

V<sub>IN</sub>=0.1V

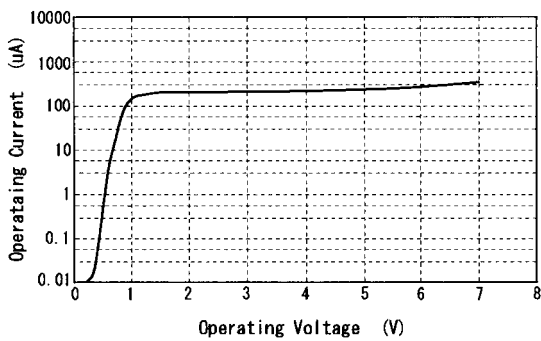

Output Current vs. Operating Voltage

V<sub>DD</sub>=0.1V

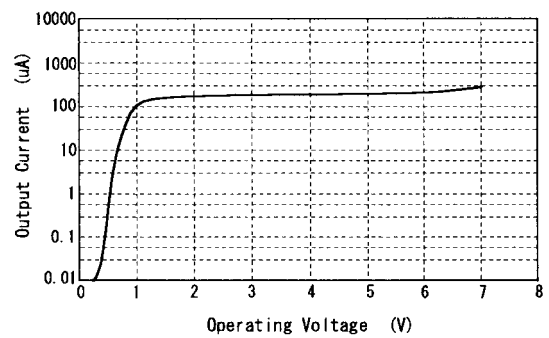



Maximum Output Swing Voltage vs. Load Resistance

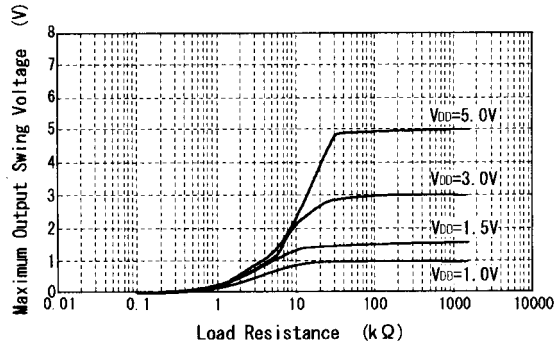

Maximum Output Swing Voltage vs. Frequency

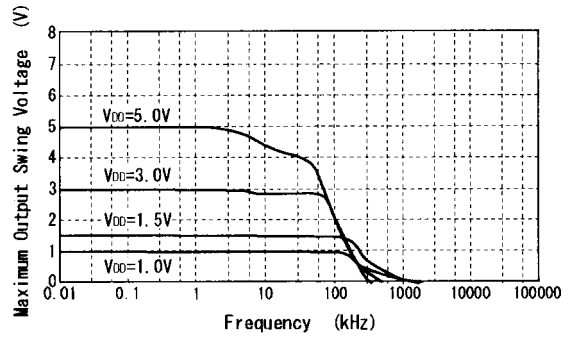

Voltage Gain-Phase vs. Frequency

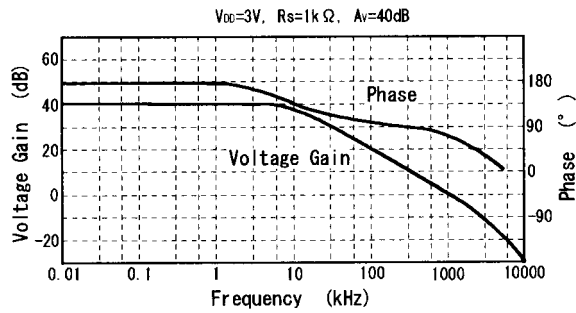

[CAUTION]

The specifications on this databook are only given for information, without any guarantee as regards either mistakes or omissions. The application circuits in this databook are described only to show representative usages of the product and not intended for the guarantee or permission of any right including the industrial rights.